

RANGE SERVANT®

<http://www.rangeservant.com>

BALL DISPENSER RS-45

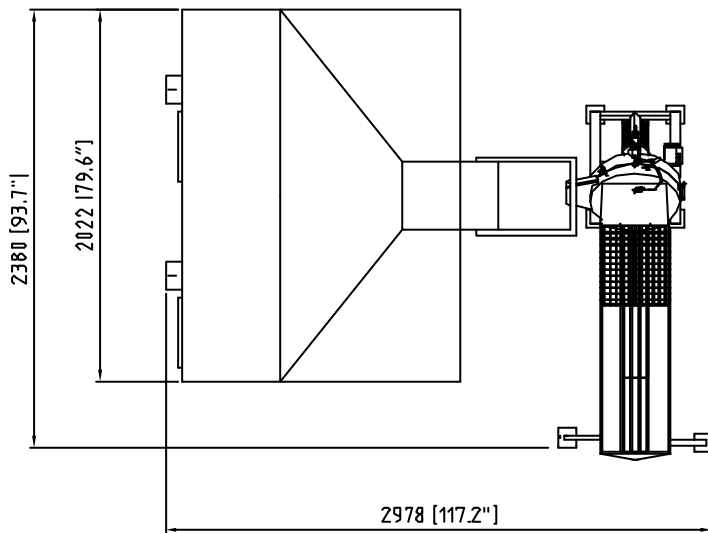
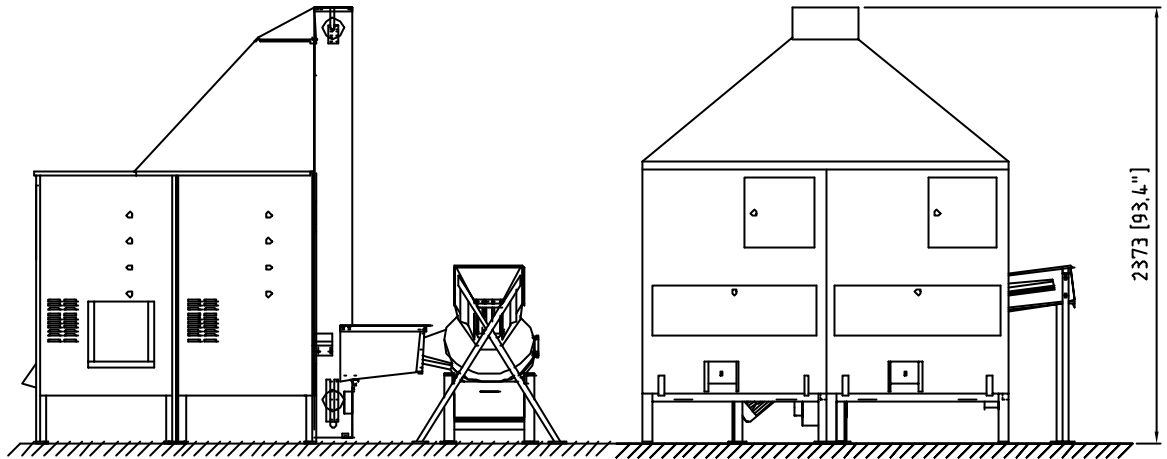

BALL DISPENSER

HOPPER CAPACITY	43 000 BALLS
SETTINGS	1X9-17X999 BALLS
MOTOR	2X70 W
VOLTAGE	230 V, 50 HZ

ELEVATOR

CAPACITY	500 BALLS/MIN
MOTOR	1.18 KW
VOLTAGE	230 V, 50 HZ

BALL WASHER

HOPPER CAPACITY	1,000 BALLS
WASHING CAPACITY	400 BALLS/MIN
MOTOR	0.55 KW
VOLTAGE	230 V, 50 HZ
PLUMBING CONNECTION	R 1/2"
WATER CONSUMPTION	4 L/MIN