

# RANGE SERVANT®

<http://www.rangeservant.com>

## BALL DISPENSER RS-11

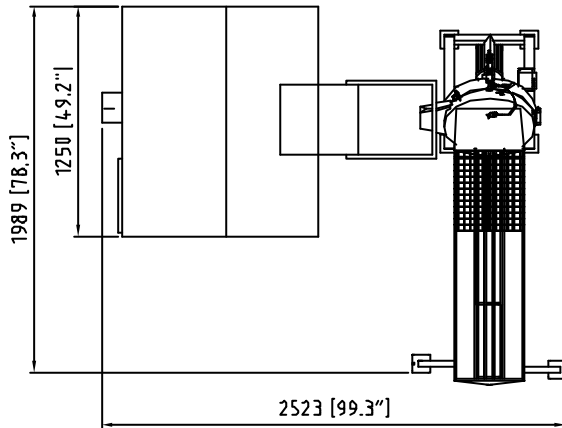
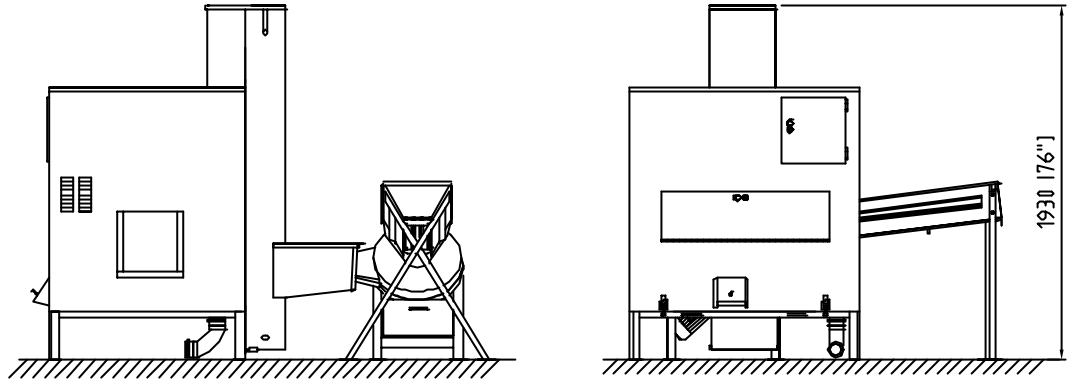

### BALL DISPENSER

HOPPER CAPACITY	11 000 BALLS
SETTINGS	1X13-23X999 BALLS
MOTOR	70 W
VOLTAGE	230 V, 50 HZ

### ELEVATOR

CAPACITY	500 BALLS/MIN
MOTOR	0.16 KW
VOLTAGE	230 V, 50 HZ

### BALL WASHER

HOPPER CAPACITY	1,000 BALLS
WASHING CAPACITY	400 BALLS/MIN
MOTOR	1.55 KW
VOLTAGE	230 V, 50 HZ
PLUMBING CONNECTION	R 1/2"
WATER CONSUMPTION	4 L/MIN